

Brodware

HALO WALL SET WITH PLEAT HANDLE

1.9506.94.9.XX

1.9506.84.9.XX Flow controlled variant

DIMENSIONS

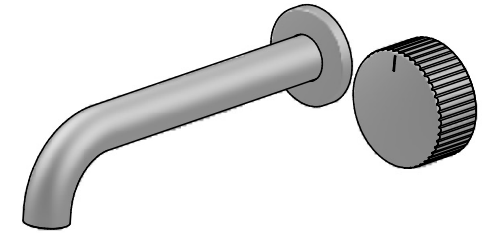

Front view:

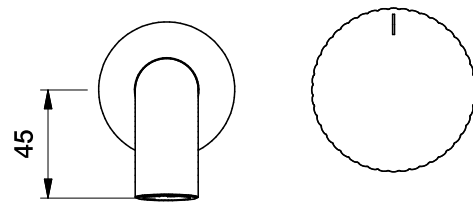

Side view:

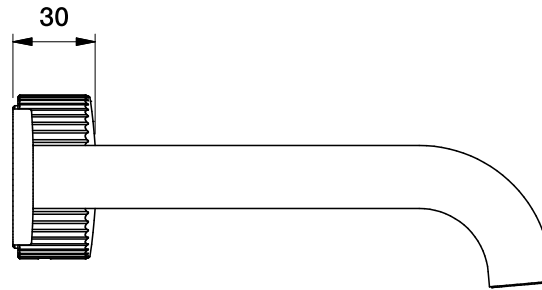

Top view:

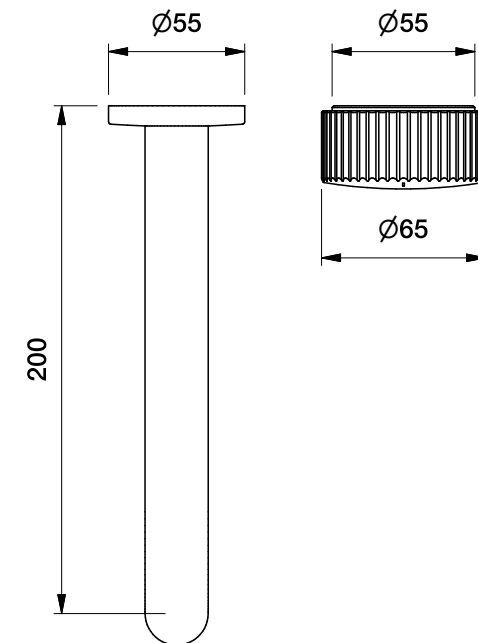

XX suffix indicates finish - **see website for colour code**

Dimensions subject to change without notice

All dimensions are approximate

Copyright © Brodware 2020

B.