

## NEU ENGLAND SHOWER SET WITH METAL LEVERS AND METAL DIVERTER

1.8025.02.3.XX



### PRODUCT DIMENSIONS:

Front view:

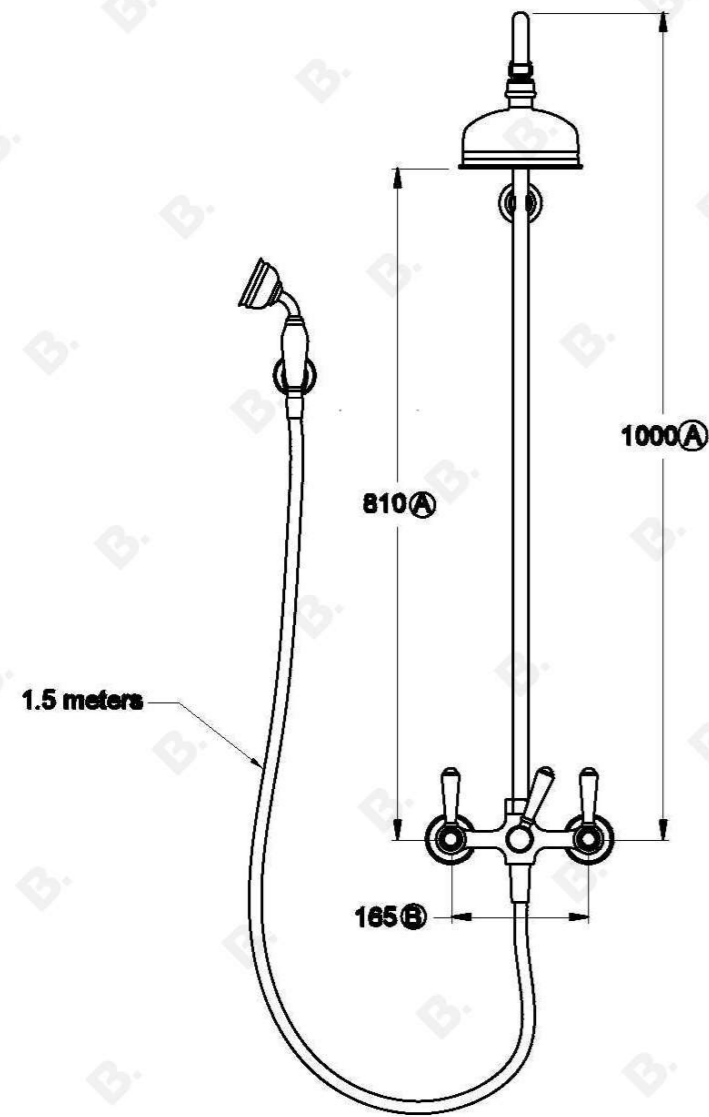

Side view:

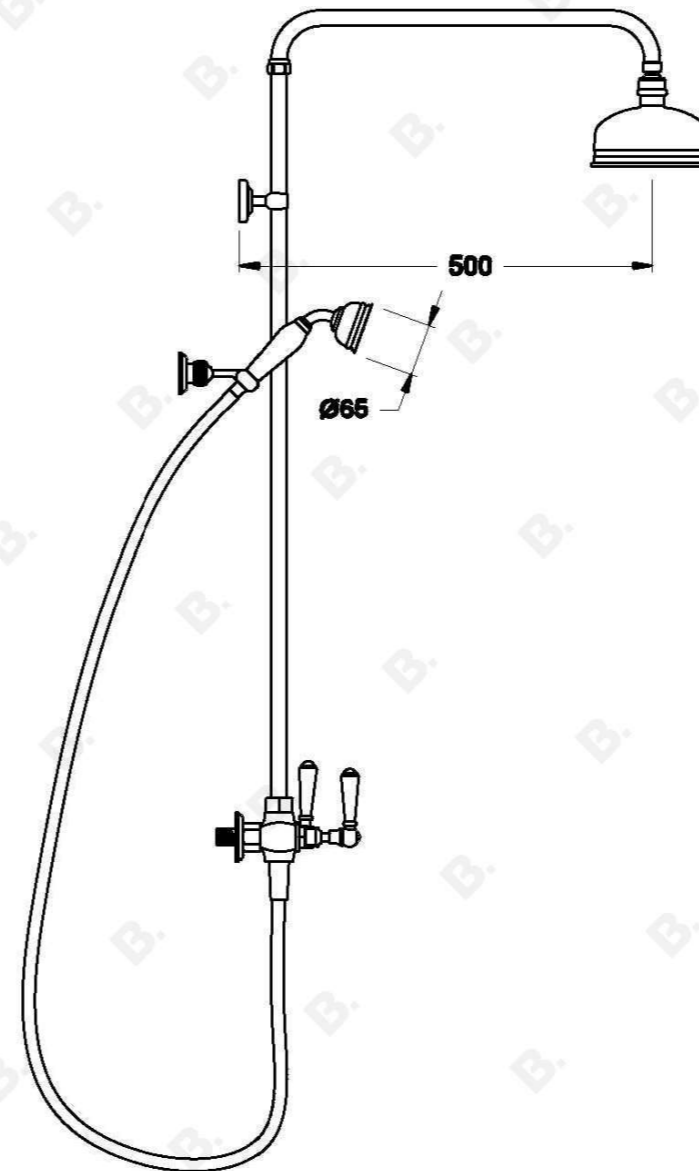

Top view:

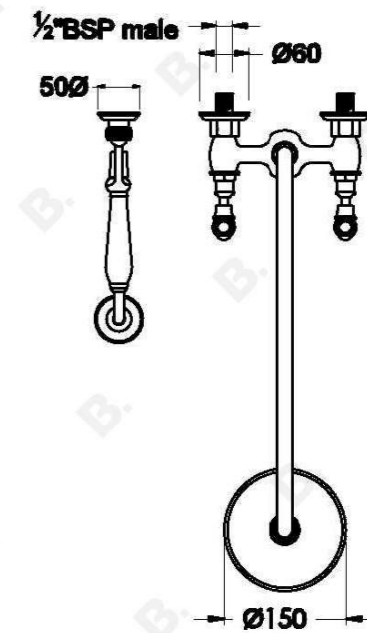

Note: G 1/2" BSP male fittings required in the wall

XX suffix indicated finish  
Dimensions subject to change without notice  
All dimensions are approximate  
B Fixed centre; taps must have 150mm centres  
A Maximum, adjustable; can be reduced at installation  
Copyright © Brodware 2020