

WINSLOW SHOWER ROSE AND ARM

1.8111.32.0.XX



PRODUCT DIMENSIONS:

Front view:

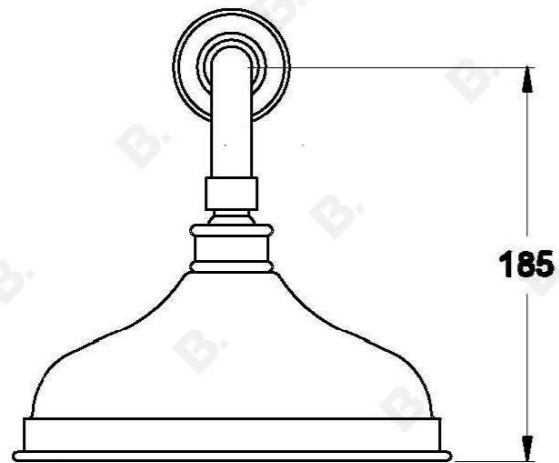

Side view:

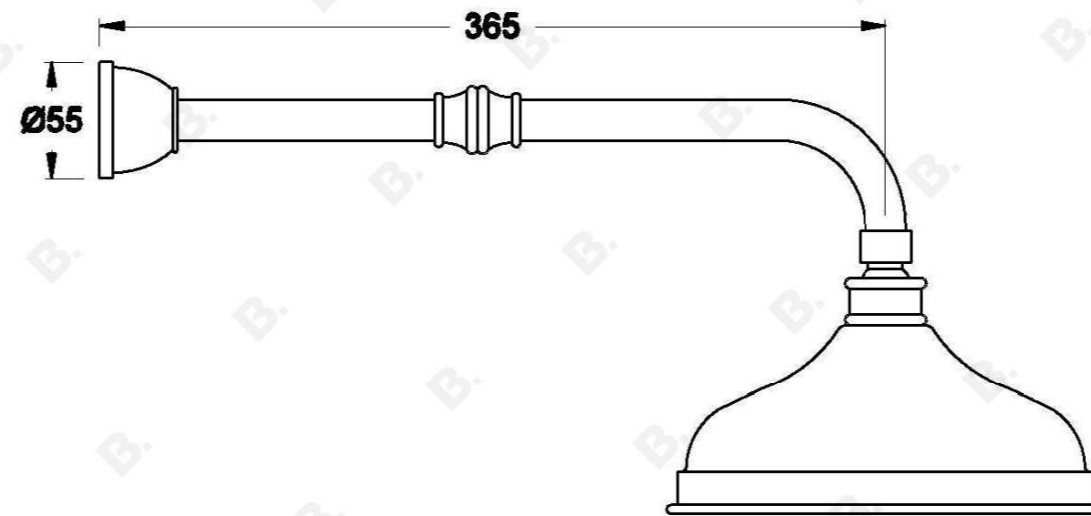

Top view:

