

## WINSLOW SHOWER ROSE AND ARM

1.8111.30.0.XX



### PRODUCT DIMENSIONS:

Front view:

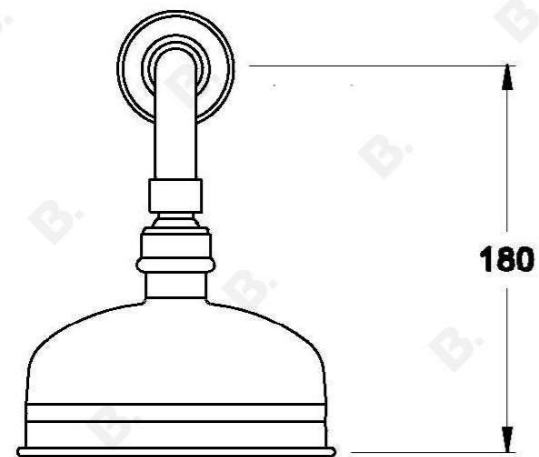

Side view:

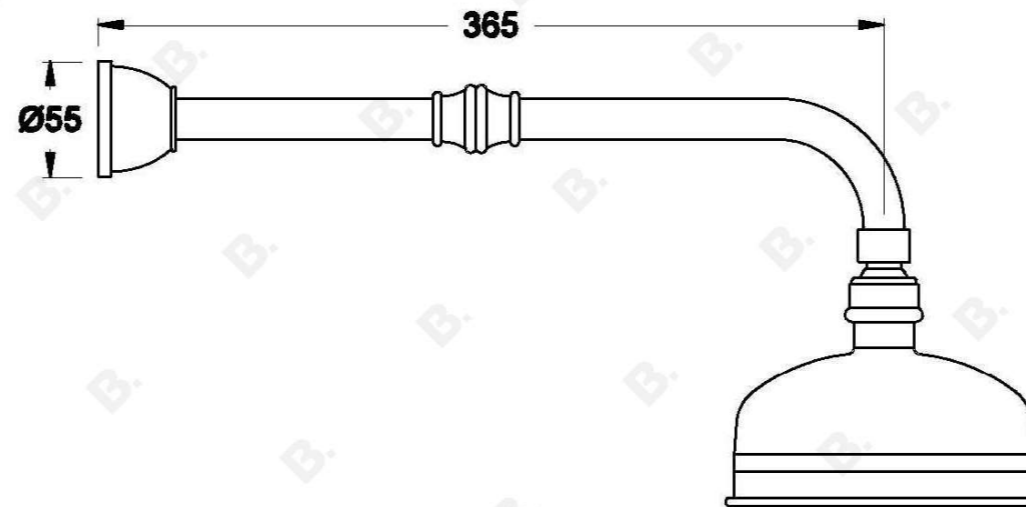

Top view:

