

WINSLOW KITCHEN SET WITH METAL LEVERS

1.8107.10.3.XX



PRODUCT DIMENSIONS:

Front view:

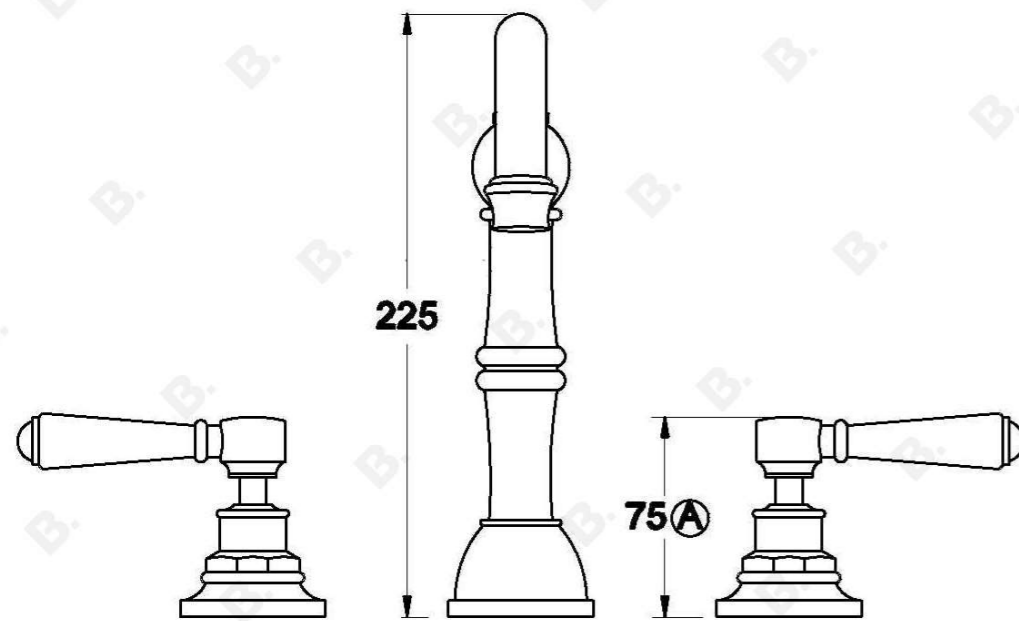

Side view:

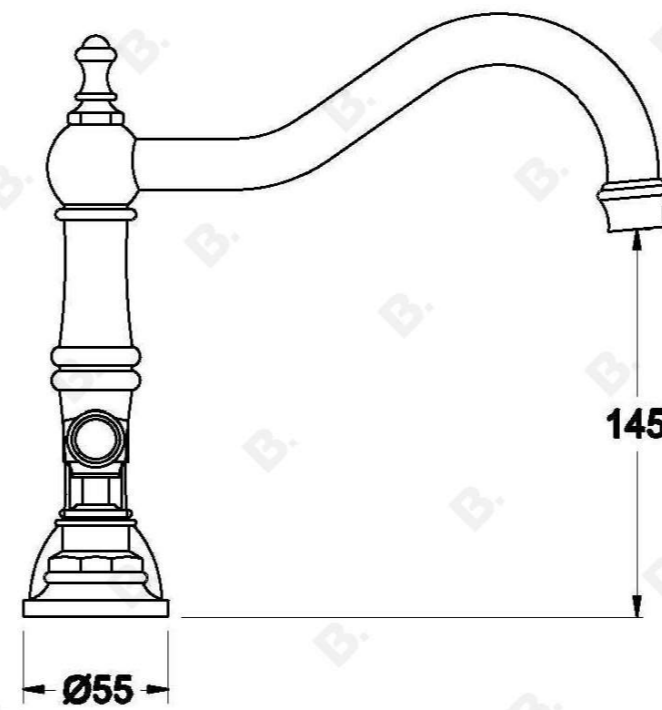

Top view:

