

WINSLOW KITCHEN SET WITH CROSS HANDLES - CERAMIC DISC

1.8107.10.2.XX



PRODUCT DIMENSIONS:

Front view:

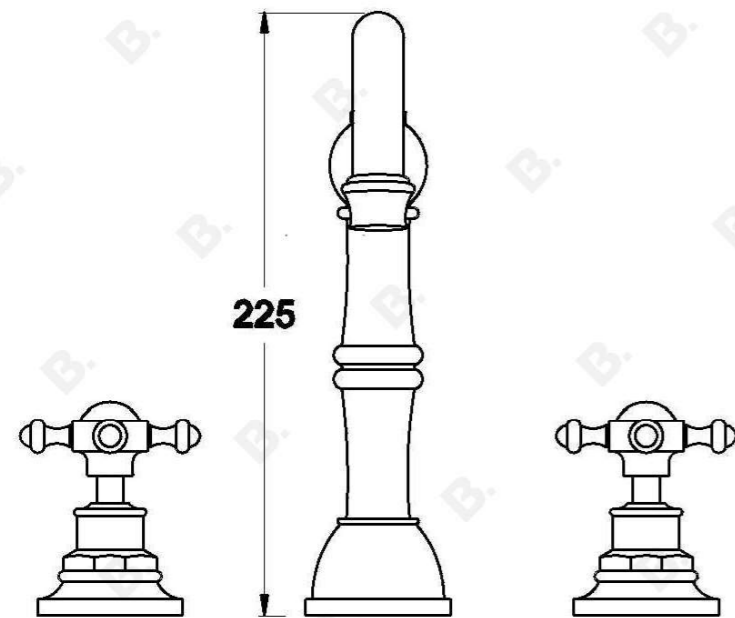

Side view:

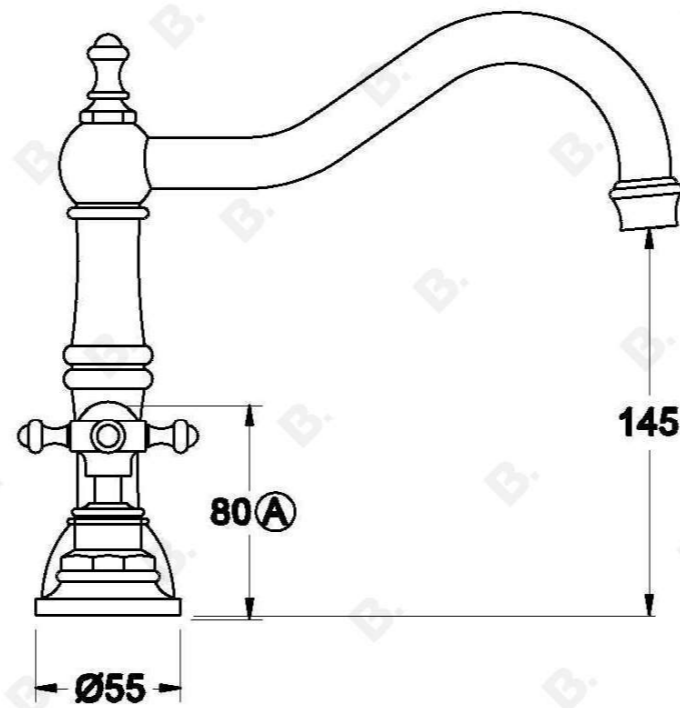

Top view:

