

WINSLOW WALL SET WITH METAL LEVERS

1.8105.00.3.XX

1.8105.50.3.XX - Flow controlled variant



PRODUCT DIMENSIONS:

Front view:

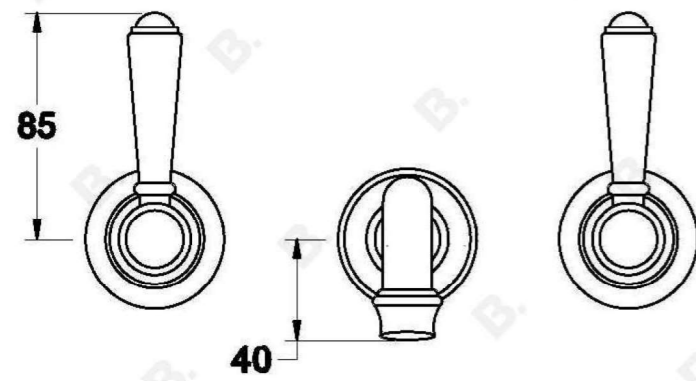

Side view:

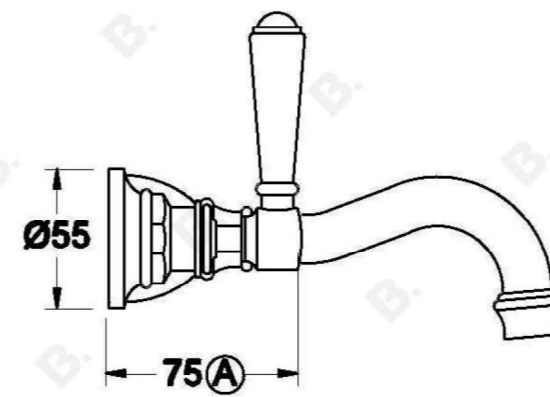

Top view:

