

Brodware

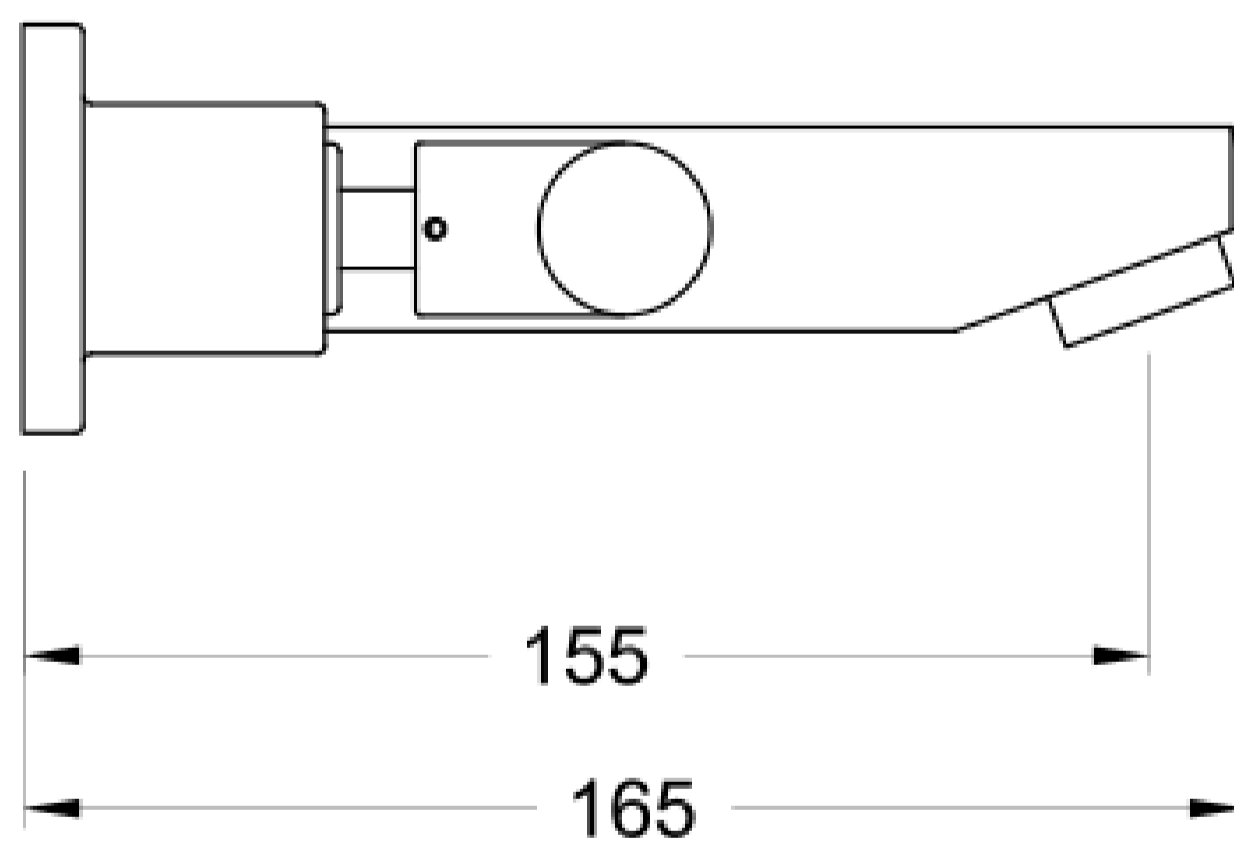

(A) Approximate distance

BROLIFE PLUS

2.1705.20.3.XX

XX Indicates finish
 Manufacturing engineers of quality commercial and residential fittings
 Dimensions subjects to change without notice. All dimensions are approximate
 Copyright © Brodware Pty Ltd 2016. www.brodware.com

Brodware